

o. Maßstab
without scale

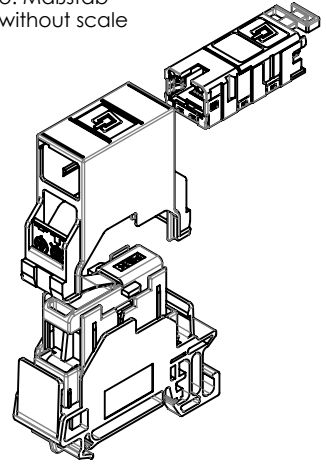

Anschlussbelegung T568A / PIN assignment T568A nach / according to TIA/EIA 568-C.2

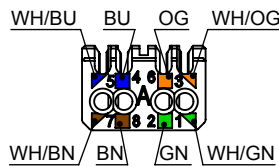

Anschlussbelegung T568B / PIN assignment T568B nach / according to TIA/EIA 568-C.2

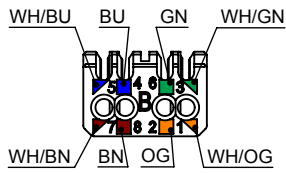

Anschlussbelegung / PIN assignment Profinet / industrial

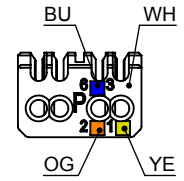

Bestell-Nr. Order no	Bezeichnung Description	Barcode EAN 13	VPE PU
J80023A0000	STX Tragschienen-Verbinder RJ45 Modul A Cat.6 _A STX mounting rail outlet RJ45 jack A Cat.6 _A	4018359341169	1
J80023A0001	STX Tragschienen-Verbinder RJ45 Modul B Cat.6 _A STX mounting rail outlet RJ45 jack B Cat.6 _A	4018359341176	1
J80023A0002	STX Tragschienen-Verbinder RJ45 Modul P Cat.6 _A STX mounting rail outlet RJ45 jack P Cat.6 _A	4018359341183	1

Bestell-Nr. Order no	Verpackung Packing	VPE PU	Karton Carton	UPE OPU	Karton Carton	UPE OPU	Karton Outer carton
J80023A0000	1 pc. in PE bag, one mounting information	1pc. in PE bag	-	10 PE bags in carton	245x170x80 [mm]	-	-
J80023A0001	1 pc. in PE bag, one mounting information	1pc. in PE bag	-	10 PE bags in carton	245x170x80 [mm]	-	-
J80023A0002	1 pc. in PE bag, one mounting information	1pc. in PE bag	-	10 PE bags in carton	245x170x80 [mm]	-	-

Änd./ rev. index	Änderungs-Nr. / revision code	Datum/ date	Name/ name	gez./ drawn	Datum/ date	Name/ name	Gewicht/ weight [g]
				gepr./ appr.	28.04.2008	KA	ca./approx.
				Maßstab/ scale	Benennung/ title		
				1:1	STX mounting rail outlet RJ45 jack A Cat.6 _A		
				untol. Maße/ dim. without tolerances according to	Untert./ doc. type	Zeichnungsnr./ drawing no.	
				D	J80023A0000		
				Ersatz für/ replaces			
				Maße/ dimensions: mm			
				Original : DIN A4			
				Blatt/ sheet 1 von/ of 4			

Optional

Staubschutzklappen sind in unterschiedlichen Farben erhältlich und müssen separat bestellt werden.
 Dust protection flaps are available in different colours and need to be ordered separately.

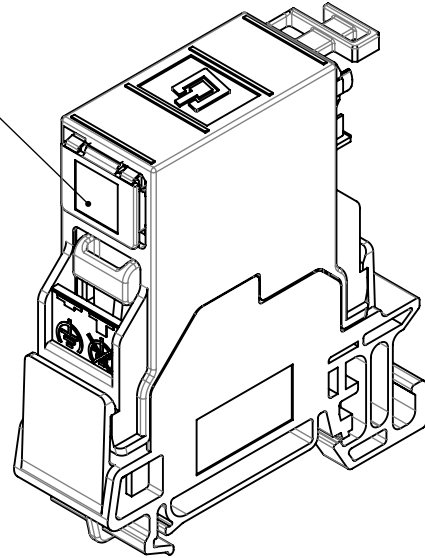

Bestell-Nr. Order no	Bezeichnung Description	Barcode EAN 13	Farbe Colour	RAL	VPE PU
B00001A0016	Retrofit dust protection flap for jacks	4018359324421	schwarz / black	RAL 9005	100 pcs in PE bag
B00001B0016	Retrofit dust protection flap for jacks	4018359324438	orange / orange	RAL 2009	100 pcs in PE bag
B00001C0016	Retrofit dust protection flap for jacks	4018359324445	grün / green	RAL 6017	100 pcs in PE bag
B00001D0016	Retrofit dust protection flap for jacks	4018359324452	blau / blue	RAL 5015	100 pcs in PE bag
B00001E0016	Retrofit dust protection flap for jacks	4018359324469	gelb / yellow	RAL 1023	100 pcs in PE bag

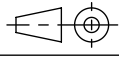
Änd./ rev. index	Änderungs-Nr. / revision code	Datum/ date	Name/ name	gez./ drawn	Datum/ date	Name/ name	Gewicht/ weight [g]	
				gepr./ appr	28.04.2008	KA		ca./approx.
b a	26601 22919	04.03.2015 25.05.2011	AS AS	Maßstab/ scale	Benennung/ title			
				1:1	STX mounting rail outlet RJ45 jack A Cat.6 _A			
				untol. Maße/ dim. without tolerances according to	Untert./ doc. type	Zeichnungsnr./ drawing no.	 Maße/ dimensions: mm	
				D		J80023A0000	Original : DIN A4	
				Ersatz für/ replaces				Blatt/ sheet 2 von/ of 4

Technische Daten / Technical Data

Steckverbinder-Norm	IEC 60603-7-51	Connector Standard
Mechanische Eigenschaften		Mechanical Characteristics
Steckkraft	≤ 30N	Insertion force
Lebensdauer (Steckzyklen RJ45 ,RJ12, RJ11)	≥ 750	Life (mating cycles RJ45, RJ12, RJ11)
Werkstoffe		Materials
Gehäuse / TS-Verbinder	PA UL94 V0 grau / grey	Housing / mounting rail
Einschub	PC UL94 V0 grau / grey	Plug-in board
Befätigungsschieber	PC UL94 V0 schwarz / black	Operator for functional earth
Erdungsfeder	Federstahl / spring steel 5-8µm Sn über / on 3µm Cu	Earth contact spring
Modulgehäuse	Zinkdruckguß / zinc diecast	Jack housing
Gehäuseoberfläche	CuSnZn	Housing finish
Schirmblech	Neusilber / German silver	Shield
Adernvorsortierung	PC UL94 V0 weiß / white	Wire presorting
Isolierwanne	PC UL94 V0 weiß / white	Insulation tank
Isolierkörper	PC UL94 V0 weiß / white	Insulation body
Leiterplatte	FR4 UL94 V0	PCB
Oberfläche Leiterplatte	chem. verzinkt / chem. tin-plated	PCB finish
Kontaktfeder	Federstahl / spring steel	Contact spring
Oberfläche Kontaktfeder	min. 0,8 µm (30µin) Au über / on 1,2 µm (50µin) Ni	Contact spring finish
Schneidklemmkontakte	CuNi2Si	IDC
Oberfläche Schneidklemmkontakte	min. 3-6µm (120-240µin) Sn	IDC finish
Kabelbinder	PA UL94 V2	Cable tie
Staubschutz-Klappdeckel	PA UL94 V0 schwarz / black	Dust protection cap
Richtlinie 2011/65/EU (RoHS)	RoHS-konform / RoHS-compliant	Directive 2011/65/EU (RoHS)
Adernanschluss		Wire Connection
Cu-Leiterdurchmesser	massiv / solid 0,40 - 0,64mm AWG 26/1 - AWG 22/1 Litze / stranded 0,48 - 0,76mm AWG 26/7 - AWG 22/7	Cu-conductor diameter
Aderndurchmesser	0,85 -1,6mm (0.034 - 0.063in.)	Insulation diameter
Wiederanschließbarkeit Schneidklemmkontakte	≤ 4 Zyklen / cycles für / for AWG 22/1 ≤ 4 Zyklen / cycles für / for AWG 22/7 ≤ 10 Zyklen / cycles für / for AWG 23/1 - AWG 26/1 ≤ 10 Zyklen / cycles für / for AWG 24/7 - AWG 26/7	Reusable IDC
Umweltanforderungen		Environmental Requirements
Mechanisch		Mechanical
Schocken	250 ms ⁻²	Shock
Schwingen sinusförmig (9Hz - 500Hz)	50 ms ⁻²	Vibration sinusoidal (9Hz - 500Hz)
Schutz vor Eindringen		Protection against Ingress
Eindringen von Teilchen	IP2X	Particulate ingress
Wasser / Untertauchen	IPX0	Water / Immersion
Klimatisch und chemisch		Climatical and Chemical
Feuchte Wärme Gehäuse TS-Verbinder	+40°C / 93% RH / 7 days	Climatic damp heat Housing mounting rail
Kälte Gehäuse TS-Verbinder	-25°C / 1 day	Coldness Housing mounting rail
Umgebungstemperatur	-40°C bis / to +70°C	Ambient temperature
Rascher Temperaturwechsel	-40°C bis / to +70°C / 25 cycles t=30min	Rapid change of temperature
Feuchte Wärme	+25°C / +65°C / 93% RH // -10°C / 21 cycles	Climatic damp heat
Strömendes Mischgas	+25°C / 73% RH / 4 days H ₂ S / SO ₂	Flowing mixed gas
Elektrische Eigenschaften		Electrical Characteristics
Kontaktwiderstand	≤ 20 mΩ	Contact resistance
Isolationswiderstand	≥ 500 MΩ	Insulation resistance

Änd./ rev. index	Änderungs-Nr. / revision code	Datum / date	Name / name	Datum / date	Name / name	Gewicht / weight [g]	
				10.04.2008	WA		
				28.04.2008	KA	ca./approx.	
				Maßstab / scale 1:1	Benennung / title STX mounting rail outlet RJ45 jack A Cat.6_A		
				untst. Maße / dim. without tolerances according to	Unterl./doc. type D	Zeichnungsnr./ drawing no. J80023A0000	
				Ersatz für / replaces			
				Telegärtner			
				Maße / dimensions: mm Original : DIN A4 Blatt / sheet 3 von / of 4			
b	26601	04.03.2015	AS				
a	22919	25.05.2011	AS				

www.telegartner.com Phone: +49 7157/125-120 Germany Phone: +49 7157/125-0 D-71144 Steinbronn Lerchenstrasse 35 Germany K.Gärtner GmbH Telegärtner © Telegärtner / all rights reserved

Spannungsfestigkeit		Voltage Proof
Kontakt-Kontakt	≥ 1000 V, DC	Contact-Contact
Kontakt-Schirm	≥ 1500 V, DC	Contact-Shield
Strombelastbarkeit bei 50°C	1 A	Current carrying capacity at 50°C
PoE+ gemäß IEEE 802.3at	Geeignet für Power over Ethernet+ Adequate for Power over Ethernet+	PoE+ according to IEEE 802.3at
Transfer-Impedanz		Transfer Impedance
Bei 1 MHz	≤ 100 mΩ	At 1 MHz
Bei 10 MHz	≤ 200 mΩ	At 10 MHz
Bei 80 MHz	≤ 1600 mΩ	At 80 MHz
Übertragungstechnische Eigenschaften *		Transmission Performance *
10 Gigabit Ethernet gemäß IEEE 802.3an	Geeignet für 10 Gigabit Ethernet Adequate for 10 Gigabit Ethernet	10 Gigabit Ethernet acc. to IEEE 802.3an
Kategorie 6 _A (Komponente)	ISO/IEC 11801; DIN EN 50173-1	Category 6 _A (Component)
Klasse E _A	ISO/IEC 11801; DIN EN 50173-1	Class E _A
Kategorie 6A	ANSI/TIA/EIA-568-C.2	Category 6A
Normen		Standards
IP-Schutzarten	IEC 60529	Degrees of protection provided by enclosures (IP code)
Niederspannungsschaltgeräte	DIN EN 60947-1 DIN EN 60947-7-1	Specification for low-voltage switchgear and controlgear
Tragschiene TH35	DIN 60715	Mounting rail TH35
Anwendungsspezifische Kommunikationskabelanlagen	Profinet Installation Guideline	Custom-designed cabling systems
Anwendungsneutrale Kommunikationskabelanlagen	ANSI/TIA/EIA-568-C.2 ISO/IEC 11801 EN 50173-1 ISO/IEC 24702 DIN EN 61918	Generic cabling systems
Zulassung		Approval
UL-gelistet Modul	E244889	UL listed jack
3P Third Party Testing Typmusterprüfung mit kontinuierlicher Produktionsüberwachung	Compliance Statement No.107364 ISO/IEC, EN & TIA/EIA Connecting Hardware Category 6, Screened Keystone Jack Electrical Transmission Performance	3P Third Party Testing Full Production Line Qualification with continuous product monitoring
3P Third Party Testing Typmusterprüfung	Attestation of Conformity No.107527 ISO/IEC, EN & TIA/EIA Screened Class E _A / Category 6A Two Connector Channel	3P Third Party Testing Type Approval
3P Third Party Testing Typmusterprüfung	Attestation of Conformity No.107526 ISO/IEC, EN & TIA/EIA Screened Class E / Category 6 Three Connector Permanent Link	3P Third Party Testing Type Approval
3P Third Party Testing Typmusterprüfung	Attestation of Conformity No.107525 ISO/IEC, EN & TIA/EIA Screened Class E / Category 6 Four Connector Channel	3P Third Party Testing Type Approval
GHMT Typmusterprüfung	Certificate No. P1756c-07 3-Connector Permanent Link (70m) bis / up to 250MHz (Cat.6)	GHMT Type Approval
GHMT Typmusterprüfung	Certificate No. P1755c-07 4-Connector Channel (90m) bis / up to 500MHz (Cat.6A)	GHMT Type Approval

* Für alle aufgeführten Standards gelten die aktuellen und publizierten Ausgabestände zum Zeitpunkt 04.03.2015.
 * The editions of the aforementioned standards by the time of 04.03.2015 are valid.

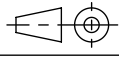
Änd./ rev. index	Änderungs-Nr. / revision code	Datum / date	Name / name	gez./ drawn	Datum / date	Name / name	Gewicht / weight [g]
				gez./ drawn	10.04.2008	WA	
				gepr./ appr.	28.04.2008	KA	ca./ approx.
				Maßstab / scale	Benennung / title		
				1:1	STX mounting rail outlet RJ45 jack A Cat.6 _A		
				untol. Maße / dim. without tolerances according to	Untert./ doc. type	Zeichnungsnr. / drawing no.	
					D	J80023A0000	
				Ersatz für / replaces			
							
				 Maße / dimensions: mm			
				Original : DIN A4			
				Blatt / sheet 4 von / of 4			

b
a